

EXS DRY SCREW VACUUM PUMP

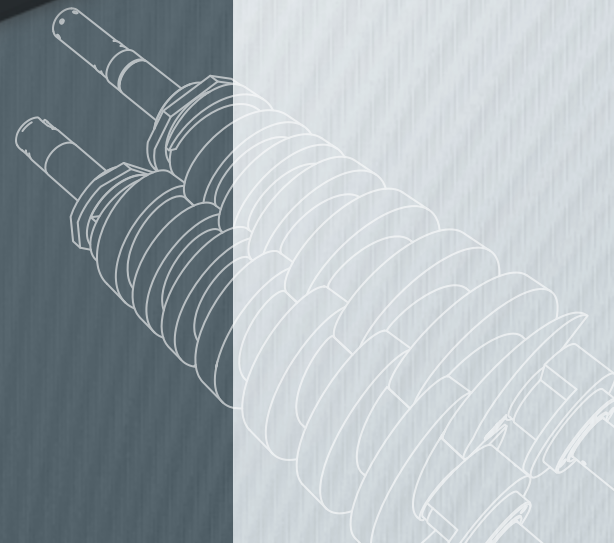

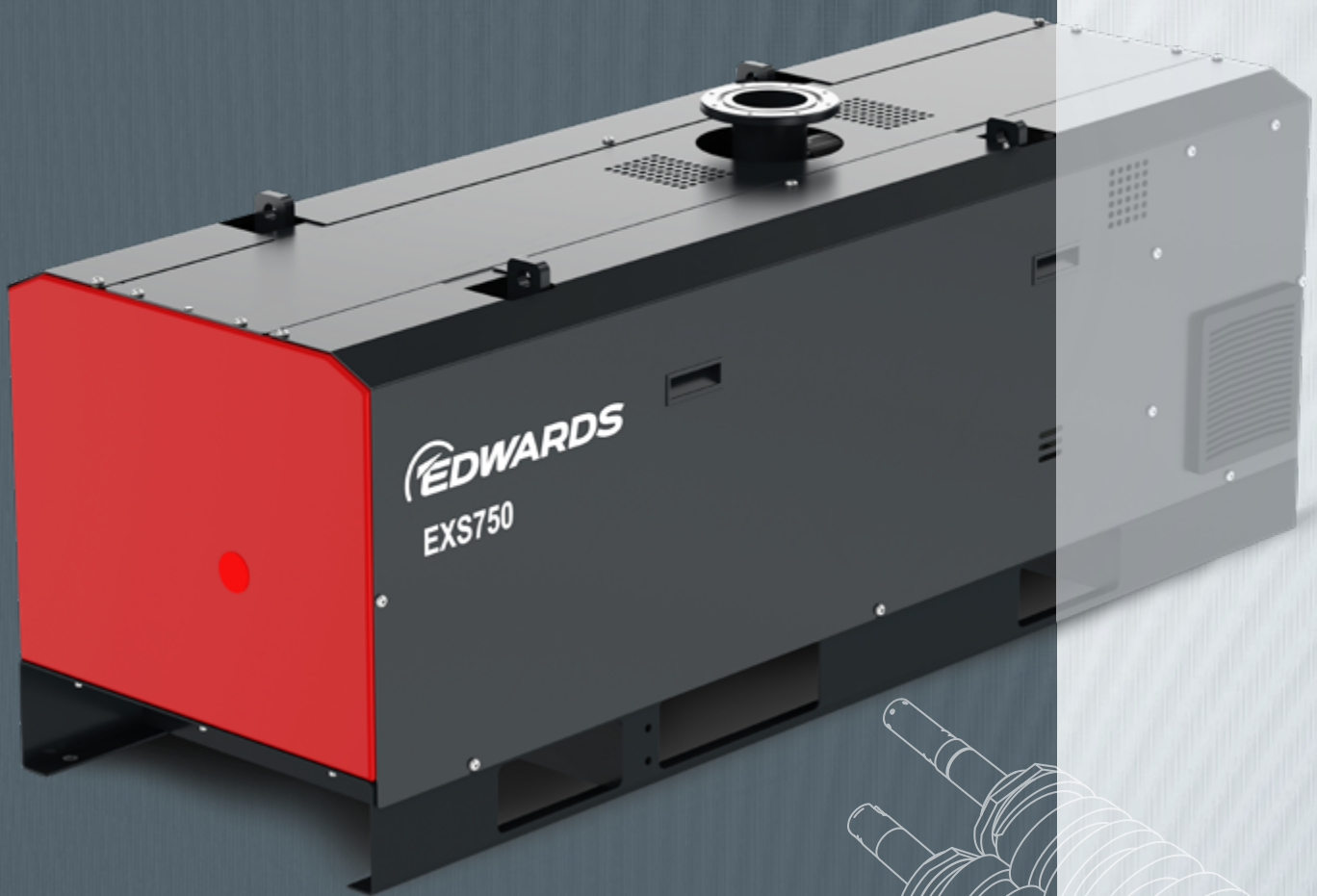

EDWARDS THE PARTNER OF CHOICE

Edwards is a world leader in the design, technology and manufacture of vacuum pumps for industrial applications with over 100 years' history.

We believe in delivering results that bring value to our customers by using our breadth of industry experience to identify and apply solutions. Using the most innovative and up-to-date modelling techniques, we can optimise the pumping configuration for customers to provide a system design giving the maximum performance in the most reliable and cost-effective way.

EXS DRY SCREW PUMPS AND COMBINATIONS

Our new EXS dry pumps take our industry proven screw vacuum technology to the next level. Based around the same technology that we use in our GXS pumps, the EXS has been designed to bring the advantages of our market leading technology in a package that focusses on simplicity and robustness. With more performance, simple control philosophy and low maintenance costs, the EXS will deliver reliable performance for many years to come.



EXS750



EXS450



- PROVEN** – Based on existing GXS technology
- **Huge install base:** on hundreds of applications
 - **Optimised design:** enables enhanced performance



- FAST** – Increased roughing speeds and low ultimate performance
- **Increased productivity:** faster processing and pump down-time
 - **Low ultimate pressure** $<1 \times 10^{-2}$



- ECONOMICAL** – Affordable capital investment and low cost of ownership
- **Substantial savings:** low utilities and energy usage costs
 - **Save on space:** small footprint



- ROBUST** – Reliable operation even in harsh industrial applications
- **Low maintenance cost:** no unplanned down-time
 - **Increased productivity:** longer intervals between service



- ENVIRONMENTAL** – Smooth, quiet running with low power and utilities consumption
- **Small carbon footprint:** low power and utilities usage
 - **Easy on environment:** no contaminated or dirty disposable oil

EXS PUMP FEATURES AND INNOVATIVE SCREW TECHNOLOGY

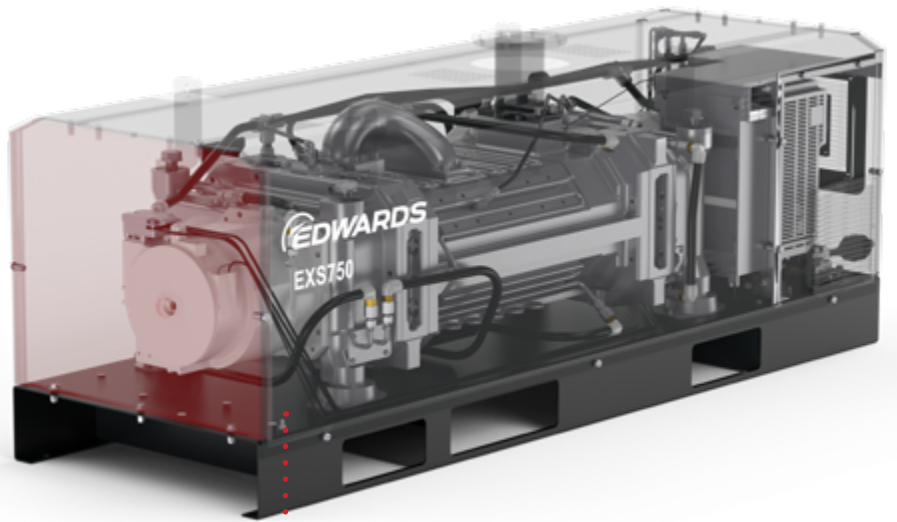
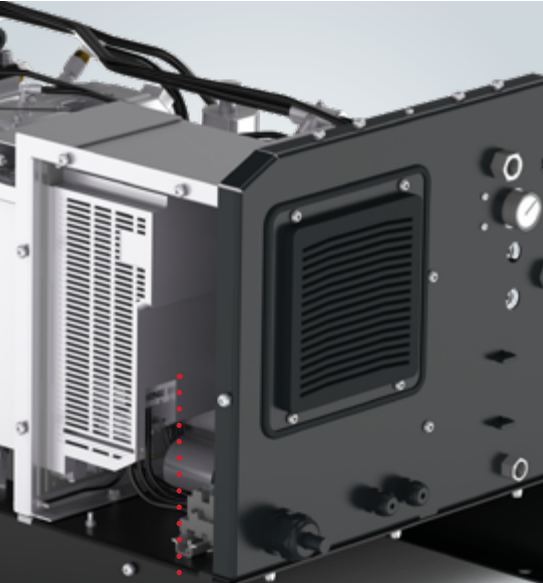

Simple Electrical Strategy

- In-built off-shelf inverter for simple connection and communication
- Electrical cabinet designed according to IP54 requirements
- Basic control philosophy for ease of installation and operation



Robust Design Features

- Reliable constant flow cooling system
- Dependable new gas system with manual gas ballast control
- Sleek sheet metal protective enclosure

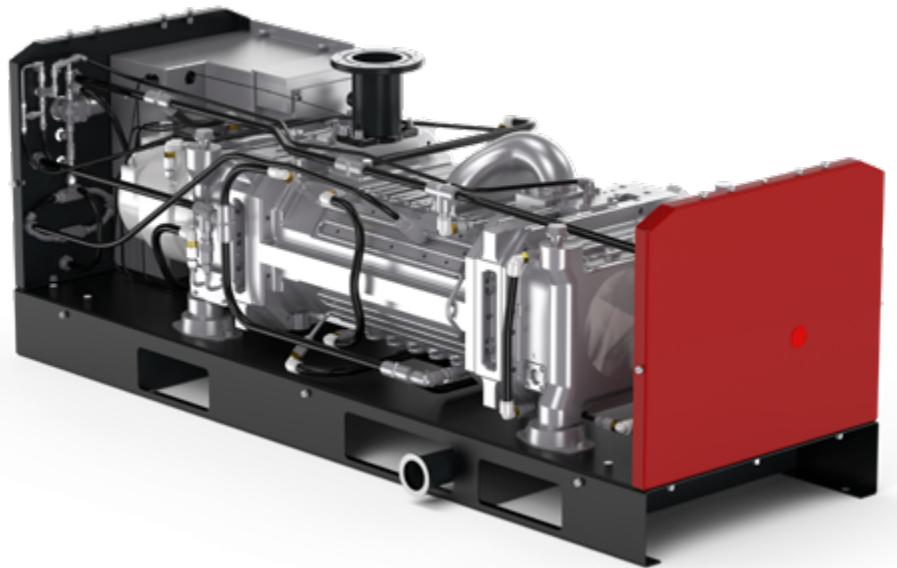
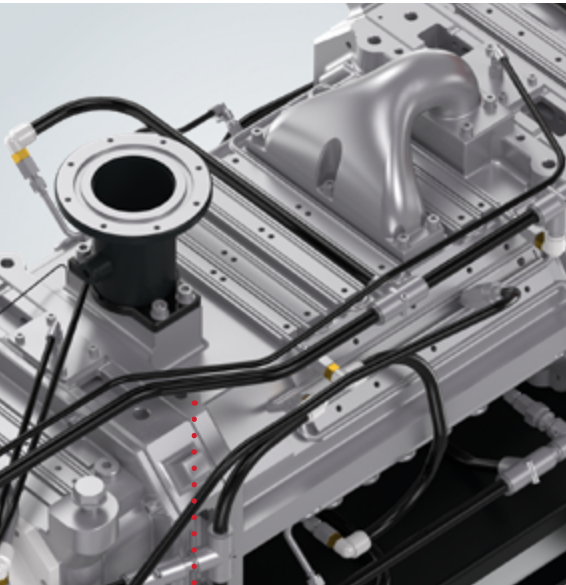

Advanced Core Technology

- Non-contacting long-life seals with integral oil blocking labyrinth seal provides highly effective sealing
- Combined with a six litre per minute seal purge the gearbox is protected from contamination and the vacuum space is kept free of oil
- Industry proven on 100s of applications
- Uses advanced quality bearings and special purpose oil with low vapour pressure for application compatibility and improved service life
- Non-cantilever design provides secure rotor support for extremely low vibration and superior starting reliability, especially on harsh processes
- Superior liquid and powder handling thanks to a sealing solution that is industry proven in 100s of applications

APPLICATIONS

The EXS pump is suitable for a range of applications in various industries including:

Metallurgy

- Vacuum brazing
- E-beam welding
- Nitro carburising
- Low pressure nitriding
- Low pressure carburising
- Carbon vapour impregnation
- Sintering
- Metal injection moulding
- Precision investment casting
- Vacuum arc refining
- Steel degassing



Plasma processes

- Plasma welding
- Plasma nitriding

Vacuum chamber evacuation

- Space simulation chambers
- Gas recovery/circulation
- Load lock chambers



LED manufacture

Solar

- Silicon crystal-pulling
- PV lamination



Coating

- Roll web coating
- Hard coating (CVD/DLC)
- Surface activation
- Plasma spray
- Glass coating

TECHNICAL SPECIFICATIONS

Specification		Unit	Value	
			EXS450	EXS750
General	Ultimate Vacuum	Mbar (Torr)	<1 x10 ⁻² (<8x10 ⁻³)	
	Peak Pumping Speed	m ³ /hr (cfm)	450 (265)	740 (435)
	Ultimate Power Full Load Power	Kw (hp)	6 (8) 16 (21.5)	10.5 (14) 22 (30)
	Maximum Rotor Speed	Rev/min	6600	
	Inlet/Outlet Flange		ISO100/NW50	
	Dimensions (mm)	LxWxH mm (in)	1265 x 567 x 642 (49.8 x 22.3 x 25.3)	1650 x 567 x 642 (65 x 22.3 x 25.3)
Cooling	Connection		G3/8" female threads	
	Cooling Flow (Always On)	l/min (gal/min)	10 (2.6)	12 (3.2)
	Maximum Supply Pressure	barg (psig)	6.9 (100)	
	Temperature	°C (°F)	5 to 40 (41 to 104)	
Purge	Connection		G1/2" female threads	
	Pressure	barg (psig)	3 – 6.9 (43.5 – 100)	
	Shaft Seal Flow (Always on)	l/min (gal/min)	12 (3.1)	
	Gas Ballast Flow (Manual Adj.)	l/min	1 – 130 (0.2-34.3)	
Operation	Ambient Temperature Range	°C (°F)	5 to 40 (41 to 104)	
	Noise Level with Silencer	dB(A)	<70	
	Maximum Exhaust Back Pressure	bar.a (psig)	1.2 (2.9)	

ORDERING INFORMATION

Pump Description	Part Number
EXS750 – HV 50/60 Hz	A41870900

PERFORMANCE CURVES

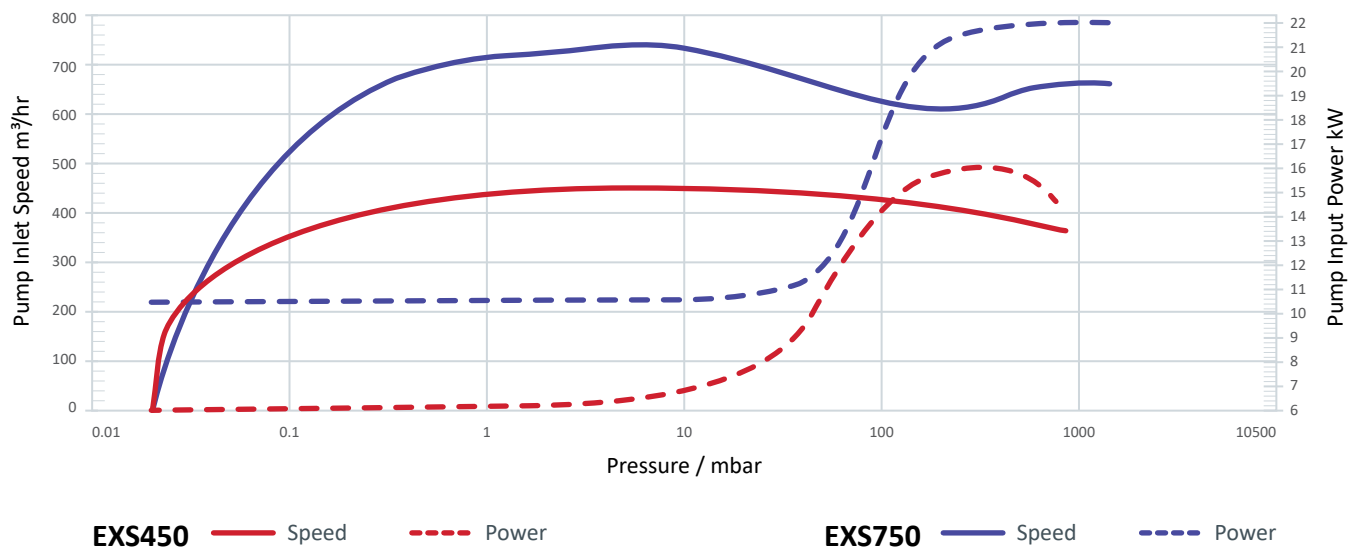

DIMENSIONS - EXS450

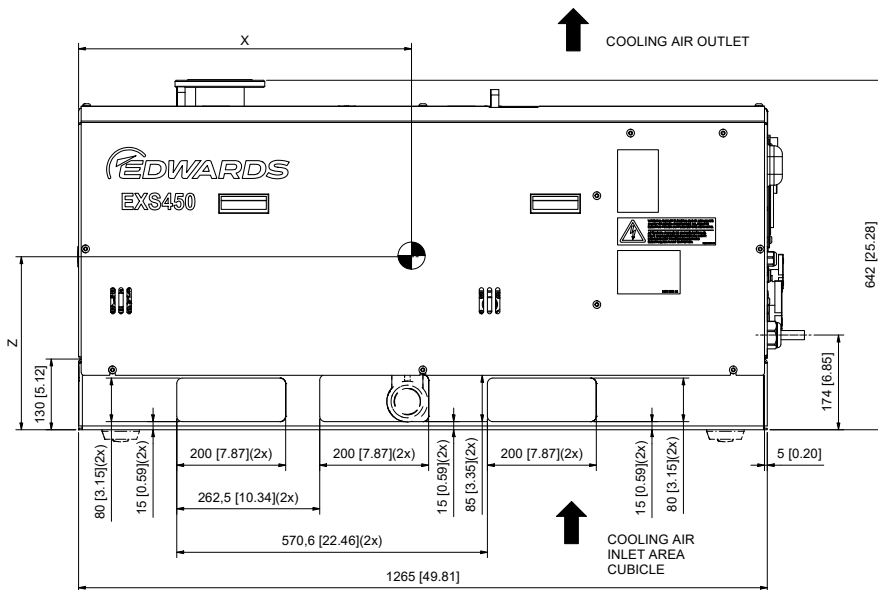
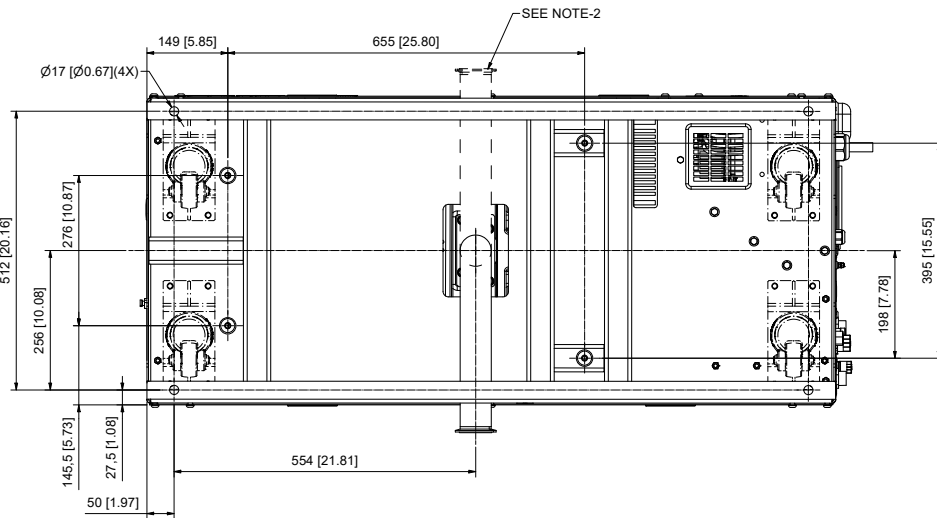
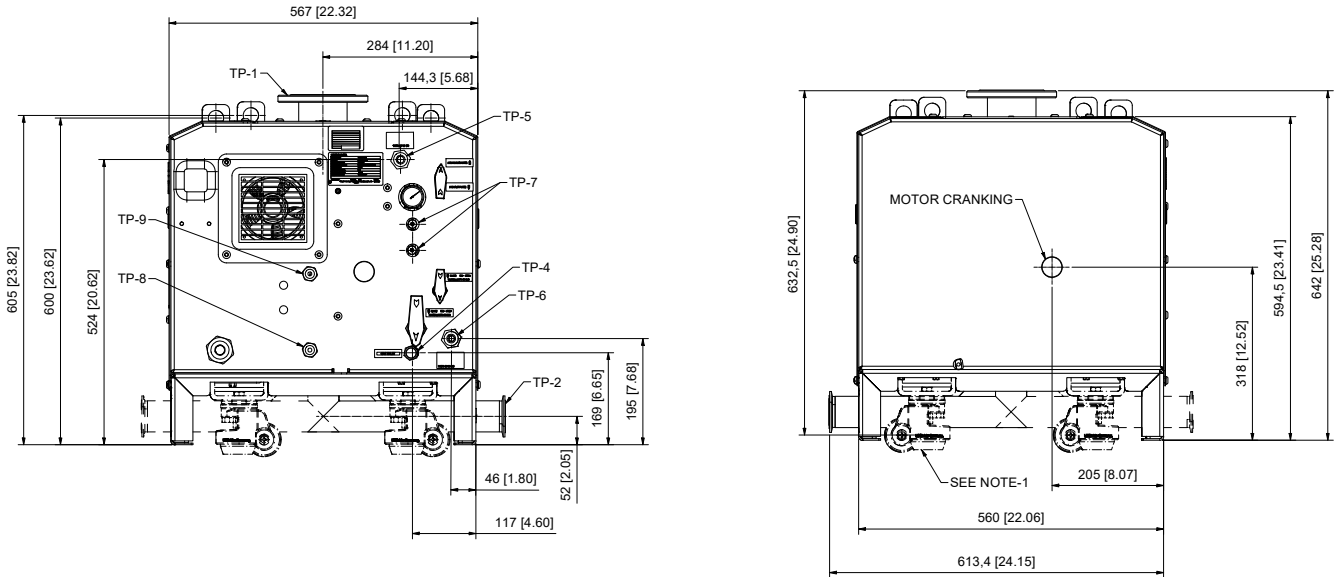

- Note:
1. Caster roller wheels are optional scope of supply. It's leveling to be done by turning the caster's thumb wheel or a screw nut on leveling pad.
 2. Exhaust outlet can be install either side as per customer preference.

DIMENSIONS - EXS750

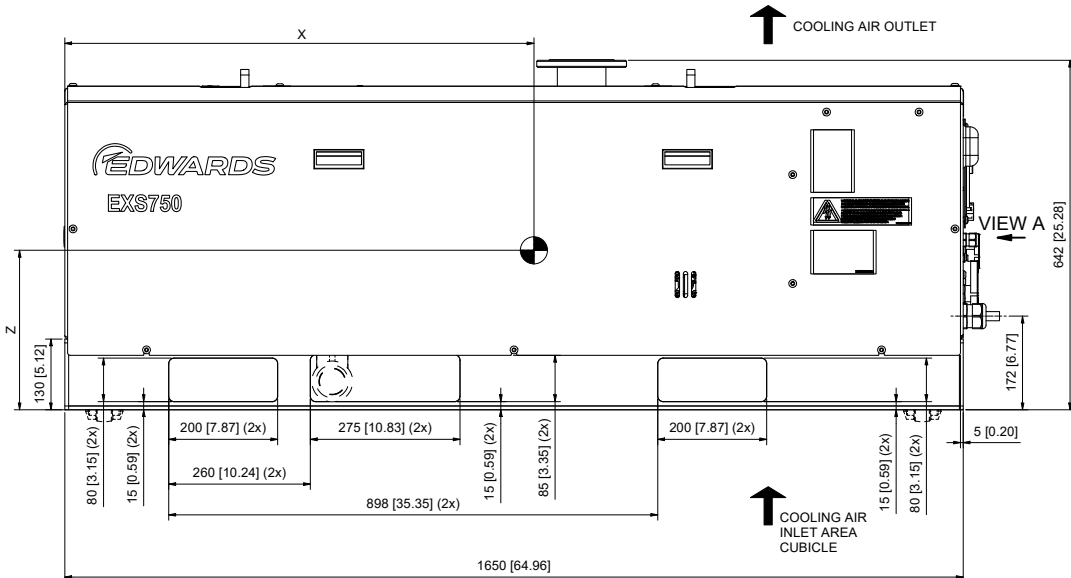
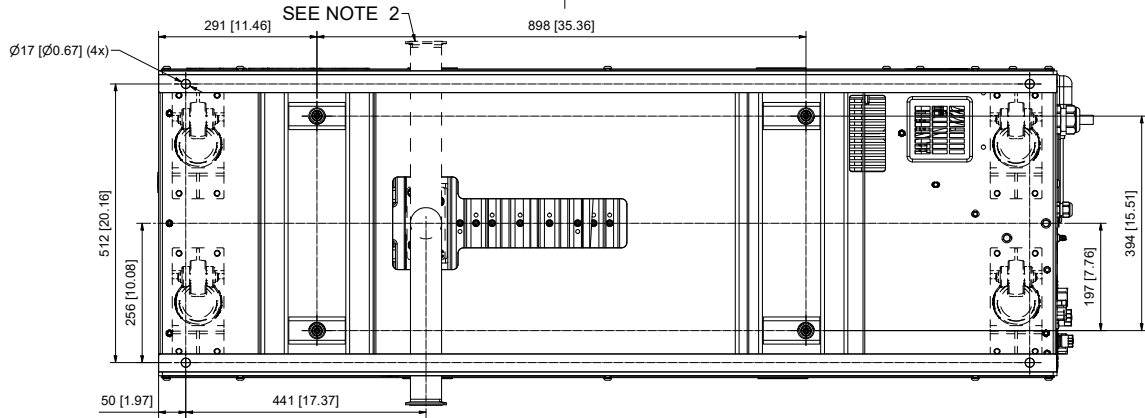
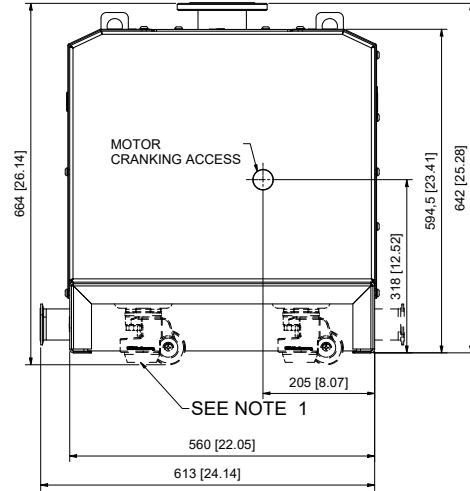
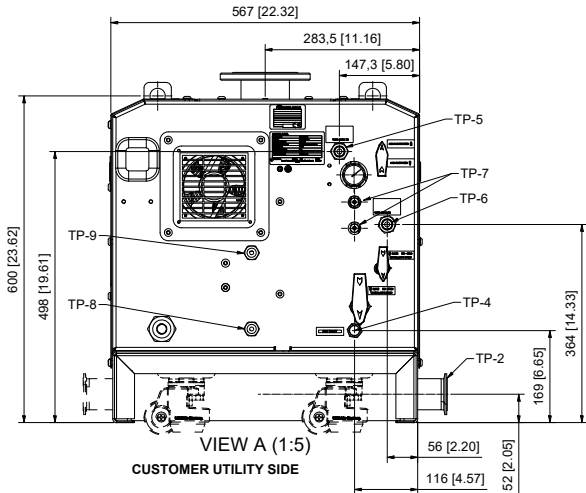

Note:

1. Caster roller wheels are optional scope of supply. It's leveling to be done by turning the caster's thumb wheel or a screw nut on leveling pad.
2. Exhaust outlet can be install either side as per customer preference.

ACCESSORIES AND SYSTEMISATION

There are a range of standard accessories available with the EXS to suit a variety of applications. All accessories can be fully integrated with EXS to provide an efficient and safe system.

Inlet and exhaust accessories

Inlet and exhaust accessories have been especially designed to match the pumping capacities of the EXS range and optimise performance.

- Foreline spool adapters for mounting instrumentation
- Booster adapter kits
- EXS castor accessory
- Inlet filter housing with polyester or stainless-steel elements
- Exhaust silencers with cleanable drainable options
- Exhaust check valves

Additional to these standard accessories, full customer specific systems are also available on request.

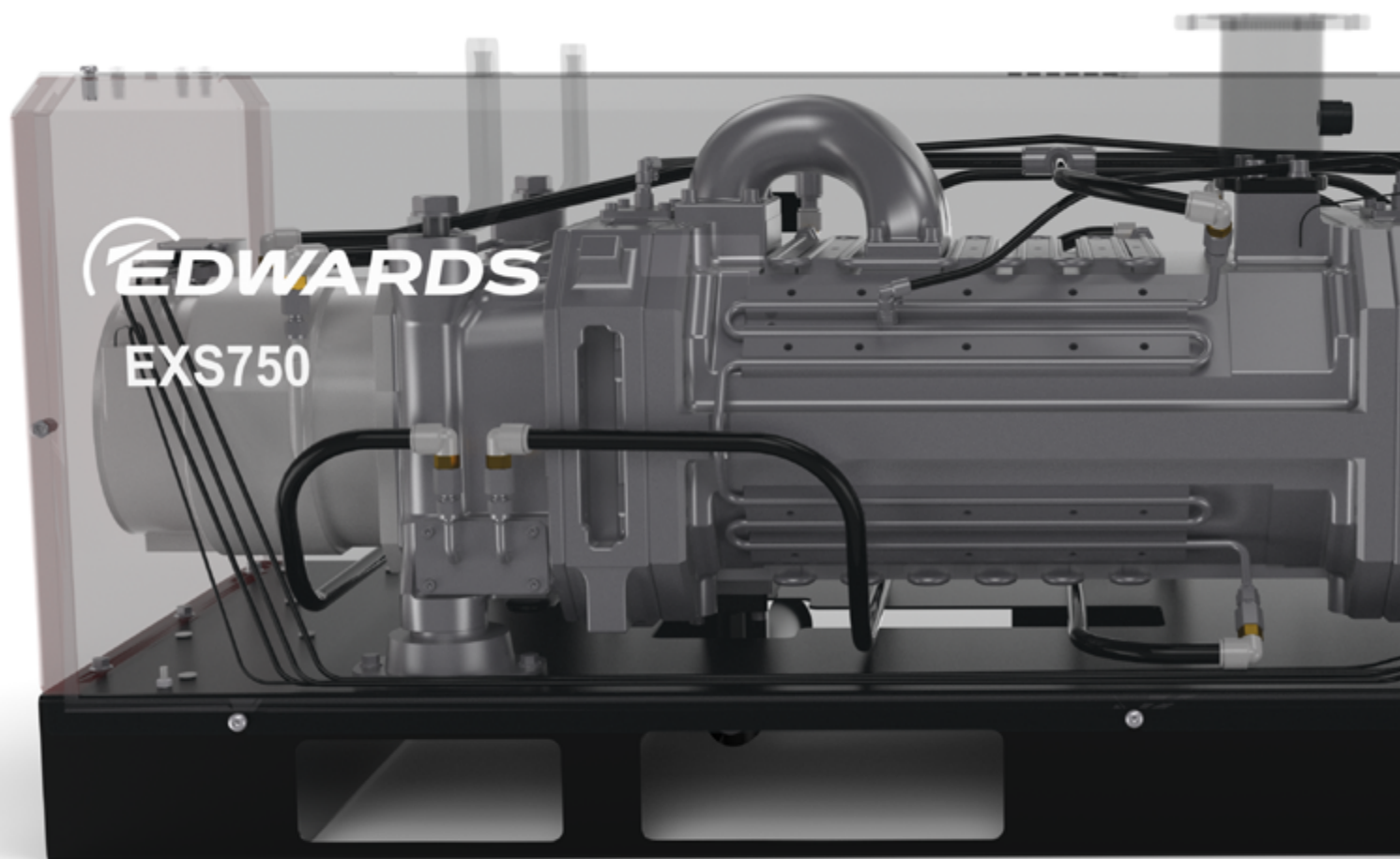

SERVICE AND SUPPORT

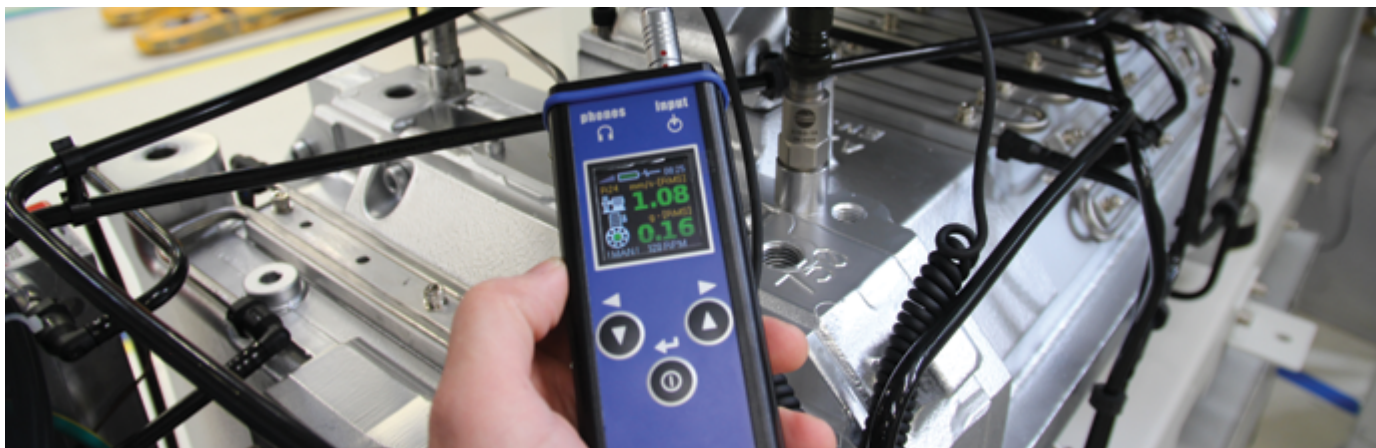

To ensure your EXS Dry Screw vacuum pump maintains optimal performance and reliability, we offer a wide range of service solutions, tailored to meet your needs. From Field Service intervention, Managed Maintenance agreements and Overhaul service in our Service Technology Centres (STC), we will take care of your pump to ensure that it continues to deliver clean, consistent, efficient performance, with lower running costs and optimum total cost of ownership for its operating life.

Selecting original spare parts, maintenance kits and oil means that every critical part performs as it was intended. Our services engineers only fit 100% genuine parts to ensure you receive the best result from each service.

Our Preventative Maintenance service packages include:

- **Health Check and Routine Service Check** - Various flexible services to keep your pump running in an optimal condition for your application, including visual inspections, pump vitals checks and replacement/cleaning of components.
- **Overhaul** - The overhaul service includes multiple service options to ensure high performance and minimal down-time
 - » **Complete Remanufacturing** including full decontamination of the pump, replacement of consumables and components tested to factory specifications.
 - » **Clean and Overhaul** includes cleaning of pump interior, repair/replacement of pipework, replacement of consumables and reassembly.
 - » **Module Exchange** includes removal and assembly of motor, gearbox, gas and water systems onto replacement pump module.
 - » **Pump Exchange** includes exchange of whole pump (including motor, gear box, gas and water systems) replaced with remanufactured pump.





GLOBAL CONTACTS

Publication Number: 3602 117 1 01
 © Edwards Limited 2021. All rights reserved.
 Edwards and the Edwards logo are trademarks of
 Edwards Limited.

Whilst we make every effort to ensure that we
 accurately describe our products and services,
 we give no guarantee as to the accuracy or
 completeness of any information provided in
 this brochure.

Edwards Ltd., registered in England and Wales
 No. 6124750, registered office: Innovation Drive,
 Burgess Hill, West Sussex, RH15 9TW, UK.

EMEA	
UK	+44 1444 253 000 (local rate) 08459 212223
Belgium	+44 1293 60 3350
France	+33 1 4121 1256
Germany	0800 000 1456
Italy	+ 39 02 48 4471
Israel	+ 972 8 681 0633
Russia	+7 495 933 55 50 Ext. 1800/1803 +8 800 775 80 99

ASIA PACIFIC	
China	+86 400 111 9618
India	+91 20 4075 2222
Japan	+81 47 458 8836
Korea	+82 31 716 7070
Singapore	+65 6546 8408
Taiwan	+886 3758 1000

AMERICAS	
USA	+1 800 848 9800
Brazil	+55 11 3952 5000